

54<sup>th</sup> INTERNATIONAL WRESTLING TOURNAMENT,  
SENIORS - FW, FS, GR  
"DAN KOLOV - NIKOLA PETROV"



# B U L E T I N

*29-31.01.2016, Sofia, Bulgaria*



54 INTERNATIONAL FS, GR & FW STYLE  
WRESTLING TOURNAMENT, SENIORS  
"DAN KOLOV" & "NIKOLA PETROV"  
29-31 JANUARY 2016, SOFIA  
"UNIVERSIADA" SPORT HALL



**Mr. Levent Sen - TUR - UWW Delegate**  
**CHIEF REFEREES: Gentshev Svetlen - BUL**  
**CHIEF SECRETARIAT: Ali Parashmolla - BUL**

**MAT "A"**

1	Markov Milen	BUL	I
4	Gevorg Aleksanyan	ARM	I
7	Lambov Ivan	BUL	I
8	Trai Belkacem	ALG	I
9	Bashirzadeh Namadal Medhi	IRI	II
10	Khadkhuu Ganbold	MGL	II
11	Lumia Paolo	ITA	III
23	Petrov Angel	BUL	III

**MAT "B"**

2	Gochev Miroslav	BUL	Is
5	Marek Mlynek	SVK	I
12	Kirilov Lyudmil	BUL	I
13	Yang Jin	CHN	I
14	Chan Carl	CAN	II
15	Molnic Ion	MDA	III
16	Sahatchiev Vasvi	BUL	III
24	Lasarov Mariancho	MKD	III

**MAT "C"**

3	Lebkowski Karol	POL	Is
6	Kostadinov Ivan	BUL	I
18	Nedev Stoyko	BUL	I
19	Izdebskyi Valeri	UKR	II
20	Alaeludin Mohhamed Siweb	EGY	II
21	Doynov Petar	BUL	II
17	Teodosi Dimitrov	BUL	II
22	Tuncer Mehmet	TUR	III

***PARTICIPANTS LIST***

N°	Country	Number of participants		
		FS	GR	FW
1	ALB	1		
2	ALG	8	6	5
3	ARG	1		
4	ARM		8	
5	BLR	3		
6	BUL	26	28	12
7	CAN	2		
8	CHI	1		
9	CHN	5		
10	EGY		6	
11	GRE			1
12	IRI	10	12	
13	ISR	1		
14	ITA	7	4	3
15	KOS	1		
16	MDA	5		4
17	MGL	6		
18	MKD	6		1
19	POL	13		
20	PUR	2		
21	RUS	1		
22	SVK	11		
23	TJK	1		
24	TUR			7
25	UKR			7
26	UZB	1		
27	VEN		6	
	<b>TOTAL:</b>	<b>112</b>	<b>70</b>	<b>40</b>

# INTERNATIONAL WRESTLING TOURNAMENT -SENIORS "DAN KOLOV - NIKOLA PETROV", 28-31.01.2016, SOFIA

1	Pays MGL	Tumenbileg Tuvshintulga	1	P1	P2	P3	
			7	3	4	0	0
2	Pays BUL	Dimitar Ivanov	3	P1	P2	P3	
			8	6	2	0	0
3	Pays MKD	Labazan Askerbiev	1	P1	P2	P3	
			2	0	2	0	0
4	Pays IRI	Peiman Biabani	3	P1	P2	P3	
			5	3	2	0	0
6	Pays BUL	Krum Chuchurov	1	P1	P2	P3	
			4	2	2	0	0
7	Pays IRI	Abolfazl Hajipouramiji	3	P1	P2	P3	
			9	4	5	0	0
9	Pays MDA	Chirtoca Alexandru	1	P1	P2	P3	
			4	1	3	0	0
12	Pays BUL	Shyukri Shyukriev	3	P1	P2	P3	
			6	6	0	0	0

2	Pays		0	P1	P2	P3	
	BUL		0	0	0	0	0
4	Pays		3	P1	P2	P3	
	IRI		7	3	4	0	0
7	Pays		4	P1	P2	P3	
	IRI		11	11	0	0	0
12	Pays		0	P1	P2	P3	
	BUL		0	0	0	0	0

4	Pays		5	P1	P2	P3	
	IRI		0	0	0	0	0
7	Pays		0	P1	P2	P3	
	IRI		0	0	0	0	0

4	Pays	Peiman Biabani					
	IRI						

CATEGORY

**61**

STYLE

**FS**

**REPECHAGE**

<b>Qualification round</b>							
5	Pays ALG	Sayeh Abderrahim	1	P1	P2	P3	
			2	2	0	0	0
6	Pays BUL	Krum Chuchurov	4	P1	P2	P3	
			12	12	0	0	0
7	Pays IRI	Abolfazl Hajipouramiji	3	P1	P2	P3	
			3	1	2	0	0
8	Pays POL	Bienkowski Krzysztof	1	P1	P2	P3	
			1	1	0	0	0
9	Pays MDA	Chirtoca Alexandru	4	P1	P2	P3	
			10	10	0	0	0
10	Pays ALG	Laissaoui Amar	0	P1	P2	P3	
			0	0	0	0	0
11	Pays MKD	Ivan Janev	0	P1	P2	P3	
			0	0	0	0	0
12	Pays BUL	Shyukri Shyukriev	4	P1	P2	P3	
			10	10	0	0	0
	Pays			P1	P2	P3	
	Pays			P1	P2	P3	
	Pays			P1	P2	P3	
	Pays			P1	P2	P3	

8	Pays		1	P1	P2	P3	
	POL		3	0	3	0	0
6	Pays		3	P1	P2	P3	
	BUL		3	1	2	0	0
3	Pays		1	P1	P2	P3	
	MKD		4	3	1	0	0
2	Pays		3	P1	P2	P3	
	BUL		8	6	2	0	0

2	Pays	Dimitar Ivanov					
	BUL						

6	Pays		3	P1	P2	P3	
	BUL		11	5	6	0	0
12			1	P1	P2	P3	
	BUL		5	0	5	0	0

6	Pays	Krum Chuchurov					
	BUL						

Rank	No	Name	Country	C.P	Falls	E.M.	E.R	Win Points	Lost Points
1	4	Peiman Biabani	IRI	11	0	0	0	12	2
2	7	Abolfazl Hajipouramiji	IRI	10	0	0	1	23	5
3	6	Krum Chuchurov	BUL	11	0	0	1	30	19
3	2	Dimitar Ivanov	BUL	6	0	0	0	16	18
5	12	Shyukri Shyukriev	BUL	8	0	0	1	21	26
5	3	Labazan Askerbiev	MKD	2	0	0	0	6	13
7	9	Chirtoca Alexandru	MDA	5	0	0	1	14	6
8	8	Bienkowski Krzysztof	POL	2	0	0	0	4	6
9	1	Tumenbileg Tuvshintulga	MGL	1	0	0	0	7	8
10	5	Sayeh Abderrahim	ALG	1	0	0	0	2	12
11	11	Ivan Janev	MKD	0	0	0	0	0	10
12	10	Laissaoui Amar	ALG	0	0	0	0	0	10

# INTERNATIONAL WRESTLING TOURNAMENT -SENIORS "DAN KOLOV - NIKOLA PETROV", 28-31.01.2016, SOFIA

CATEGORY **74**

STYLE **FS**

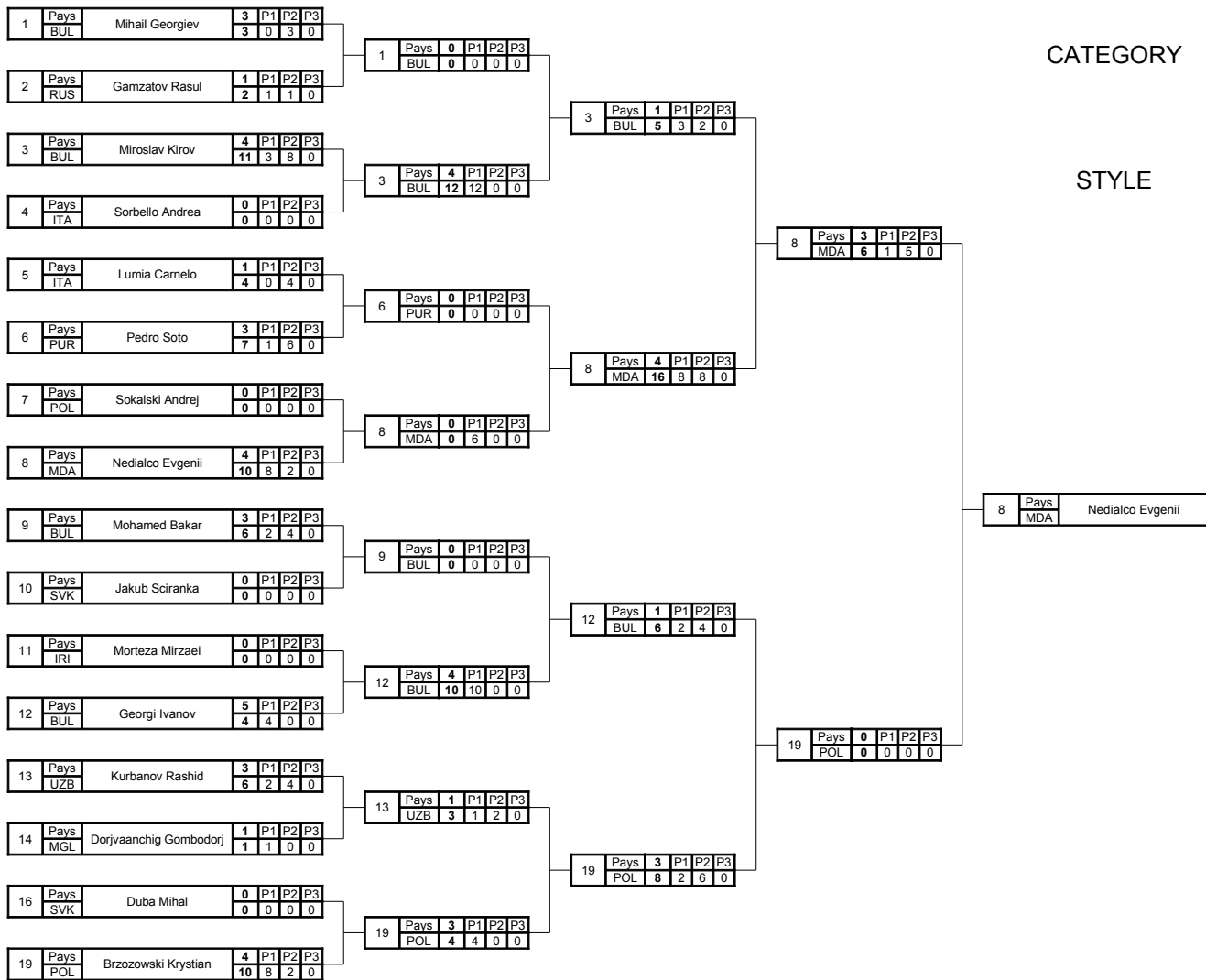

**Qualification round**

14	MGL	Dorjvaanchig Gombodorj	4	10	0	0
15	ALG	Moussaoui Hamza	0	0	0	0
16	SVK	Duba Mihal	3	8	1	7
17	BLR	Karpach Andrei	1	4	4	0
18	SVK	Palinkas Dan	0	0	0	0
19	POL	Brzozowski Krystian	4	10	0	0
Pays						
Pays						
Pays						
Pays						
Pays						
Pays						
Pays						
Pays						
Pays						
Pays						
Pays						
Pays						
Pays						
Pays						
Pays						
Pays						
Pays						
Pays						
Pays						
Pays						

**REPECHAGE**

**LOWER BRANCH**

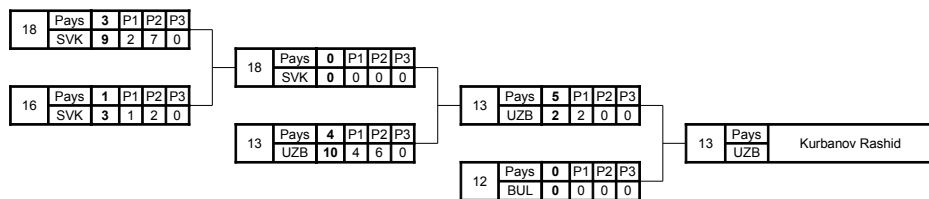

**UPPER BRANCH**

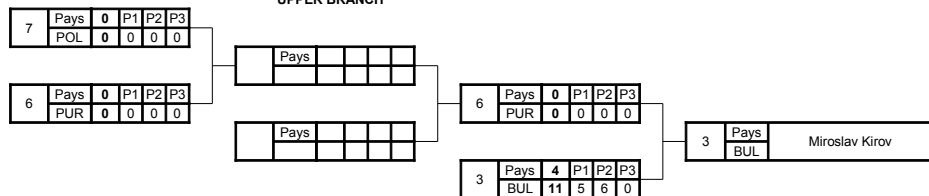



**INTERNATIONAL WRESTLING  
TOURNAMENT - SENIORS - FS**  
\*DAN KOLOV - NIKOLA PETROV\*, 29-31.1.2016, SOFIA

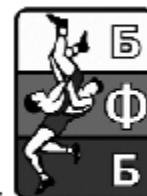

Category 74

Rank	No	Name	Country	C.P	Falls	E.M.	E.R	Win Points	Lost Points
1	8	Nedialco Evgenii	MDA	11	1	0	3	32	5
2	19	Brzozowski Krystian	POL	14	0	0	2	32	15
3	13	Kurbanov Rashid	UZB	13	1	0	1	21	5
3	3	Miroslav Kirov	BUL	13	0	0	3	39	16
5	12	Georgi Ivanov	BUL	10	1	0	1	20	10
5	6	Pedro Soto	PUR	3	0	0	0	7	15
7	14	Dorjvaanchig Gombodorj	MGL	5	0	0	1	11	6
8	16	Duba Mihal	SVK	4	0	0	1	11	23
9	18	Palinkas Dan	SVK	3	0	0	0	9	23
10	9	Mohamed Bakar	BUL	3	0	0	0	6	10
11	1	Mihail Georgiev	BUL	3	0	0	0	3	14
12	5	Lumia Carnelo	ITA	1	0	0	0	4	7
13	17	Karpach Andrei	BLR	1	0	0	0	4	8
14	2	Gamzatov Rasul	RUS	1	0	0	0	2	3
15	11	Morteza Mirzaei	IRI	0	0	0	0	0	4
16	10	Jakub Sciranka	SVK	0	0	0	0	0	6
17	7	Sokalski Andrej	POL	0	0	0	0	0	10
18	15	Moussaoui Hamza	ALG	0	0	0	0	0	10
19	4	Sorbello Andrea	ITA	0	0	0	0	0	11





**INTERNATIONAL WRESTLING  
TOURNAMENT - SENIORS - FS**  
**"DAN KOLOV - NIKOLA PETROV", 29-31.1.2016, SOFIA**

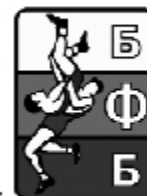

Category 57

Rank	No	Name	Country	C.P	Falls	E.M.	E.R	Win Points	Lost Points
1	8	Vladimir Dubov	BUL	15	0	0	3	35	4
2	10	Mehmed Feraim	BUL	9	0	0	0	12	16
3	11	John Pineda	CAN	10	0	0	0	20	15
3	3	Georgi Vangelov	BUL	13	1	0	2	20	14
5	6	Damdinbazar Tsogtbaatar	MGL	9	0	0	1	23	9
5	20	Buruianu Anatolii	MDA	11	0	0	1	32	27
7	16	Stoyan Iliev	BUL	8	0	0	1	27	21
8	18	Yuriy Holub	ISR	6	0	0	0	8	8
9	13	Ogonowski Tomasz	POL	4	0	0	1	20	15
10	1	Rynchynau Dzimchyk	BLR	3	0	0	0	11	12
11	9	Davidovi Givi	ITA	2	0	0	0	6	8
12	14	Agustin Destribats	ARG	1	0	0	0	7	13
13	12	Yones Emamichoghaei	IRI	1	0	0	0	4	6
14	2	Elmedin Sejfulau	MKD	1	0	0	0	2	11
15	7	Hajduk Adrian	POL	1	0	0	0	2	16
16	17	Kheyrollah Ghahremani	IRI	0	0	0	0	0	0
17	19	Mannino Salvatore	ITA	0	0	0	0	0	6
18	4	Kherbache Abdelhak	ALG	0	0	0	0	0	6
19	15	Molnar Ivan	SVK	0	0	0	0	0	11
20	5	Cangiano Alessandro	ITA	0	0	0	0	0	11

# INTERNATIONAL WRESTLING TOURNAMENT -SENIORS "DAN KOLOV - NIKOLA PETROV", 28-31.01.2016, SOFIA

1	Pays	Hadri Billel	0	P1	P2	P3
	ALG		0	0	0	0
3	Pays	Ali Mojerloo	4	P1	P2	P3
	IRI		10	10	0	0
4	Pays	Jezierzanski Sebastian	5	P1	P2	P3
	POL		9	5	4	0
6	Pays	Lin Zushen	0	P1	P2	P3
	CHN		0	0	0	0
9	Pays	Baranowski Zbigniew	4	P1	P2	P3
	POL		11	7	4	0
10	Pays	Evelin Rusev	0	P1	P2	P3
	BUL		0	0	0	0
13	Pays	Mihail Ganev	0	P1	P2	P3
	BUL		0	0	0	0
14	Pays	Orgodol Uitumen	5	P1	P2	P3
	MGL		2	2	0	0

3	Pays	4	P1	P2	P3
	IRI	10	6	6	0

3	Pays	3	P1	P2	P3
	IRI	4	2	2	0

4	Pays	0	P1	P2	P3
	POL	0	0	0	0

9	Pays	1	P1	P2	P3
	POL	3	0	3	0

14	Pays	1	P1	P2	P3
	MGL	6	2	4	0

### REPECHAGE LOWER BRANCH

8	Pays	4	P1	P2	P3
	SVK	12	12	0	0

8	Pays	0	P1	P2	P3
	SVK	0	0	0	0

10	Pays	1	P1	P2	P3
	BUL	2	2	0	0

14	Pays	4	P1	P2	P3
	MGL	11	4	7	0

### UPPER BRANCH

2	Pays	4	P1	P2	P3
	BUL	12	10	2	0

2	Pays	1	P1	P2	P3
	BUL	1	0	1	0

1	Pays	1	P1	P2	P3
	ALG	1	1	0	0

4		3	P1	P2	P3
	POL	2	1	1	0

### Qualification round

2	Pays	Svetoslav Dimitrov	1	P1	P2	P3
	BUL		3	0	3	0
3	Pays	Ali Mojerloo	3	P1	P2	P3
	IRI		4	4	0	0
4	Pays	Jezierzanski Sebastian	3	P1	P2	P3
	POL		7	4	3	0
5	Pays	Rene Matejov	1	P1	P2	P3
	SVK		2	0	2	0
6	Pays	Lin Zushen	3	P1	P2	P3
	CHN		9	1	8	0
7	Pays	Raffi William	0	P1	P2	P3
	ITA		0	0	0	0
8	Pays	Michael Bodnar	0	P1	P2	P3
	SVK		0	0	0	0
9	Pays	Baranowski Zbigniew	4	P1	P2	P3
	POL		10	4	6	0
10	Pays	Evelin Rusev	3	P1	P2	P3
	BUL		8	5	3	0
11	Pays	Georgi Dimitrov	1	P1	P2	P3
	BUL		4	0	4	0
12	Pays	Arashk Mohebi	0	P1	P2	P3
	IRI		0	0	2	0
13	Pays	Mihail Ganev	3	P1	P2	P3
	BUL		5	1	4	0
14	Pays	Orgodol Uitumen	3	P1	P2	P3
	MGL		10	3	7	0
15	Pays	Purevjav Unurbat	1	P1	P2	P3
	MGL		5	3	2	0

CATEGORY **86**

STYLE **FS**

3	Pays	Ali Mojerloo
	IRI	

14	Pays	Orgodol Uitumen
	MGL	

4	Pays	Jezierzanski Sebastian
	POL	

Rank	No	Name	Country	C.P	Falls	E.M.	E.R	Win Points	Lost Points
1	3	Ali Mojerloo	IRI	14	0	1	3	28	6
2	9	Baranowski Zbigniew	POL	12	0	0	2	34	10
3	14	Orgodol Uitumen	MGL	13	1	0	1	29	15
3	4	Jezierzanski Sebastian	POL	11	1	0	0	18	13
5	8	Michael Bodnar	SVK	4	0	0	1	12	23
5	2	Svetoslav Dimitrov	BUL	6	0	0	1	16	7
7	10	Evelin Rusev	BUL	4	0	0	0	10	27
8	6	Lin Zushen	CHN	3	0	0	1	9	9
9	13	Mihail Ganev	BUL	3	0	0	0	5	2
10	15	Purevjav Unurbat	MGL	1	0	0	0	5	10
11	11	Georgi Dimitrov	BUL	1	0	0	0	4	8
12	5	Rene Matejov	SVK	1	0	0	0	2	7
13	1	Hadri Billel	ALG	1	0	0	0	1	22
14	12	Arashk Mohebi	IRI	0	0	0	0	0	5
15	7	Raffi William	ITA	0	0	0	0	0	9



# INTERNATIONAL WRESTLING TOURNAMENT -SENIORS "DAN KOLOV - NIKOLA PETROV", 28-31.01.2016, SOFIA

1	Pays	Skaskewicz K.	0	P1	P2	P3
	POL		0	0	0	0
2	Pays	Amirreza Amiri	5	P1	P2	P3
	IRI		0	0	0	0
3	Pays	Bouزيد Lounes	5	P1	P2	P3
	ALG		8	4	4	0
4	Pays	Uharek Tomas	0	P1	P2	P3
	SVK		1	1	0	0
5	Pays	Baran Robert	5	P1	P2	P3
	POL		10	3	7	0
8	Pays	Shang Hai	0	P1	P2	P3
	CHN		6	6	0	0
9	Pays	Deng Zhiwei	3	P1	P2	P3
	CHN		7	1	6	0
11	Pays	Korey Jarvis	0	P1	P2	P3
	CAN		0	0	0	0

CATEGORY **125**

STYLE **FS**

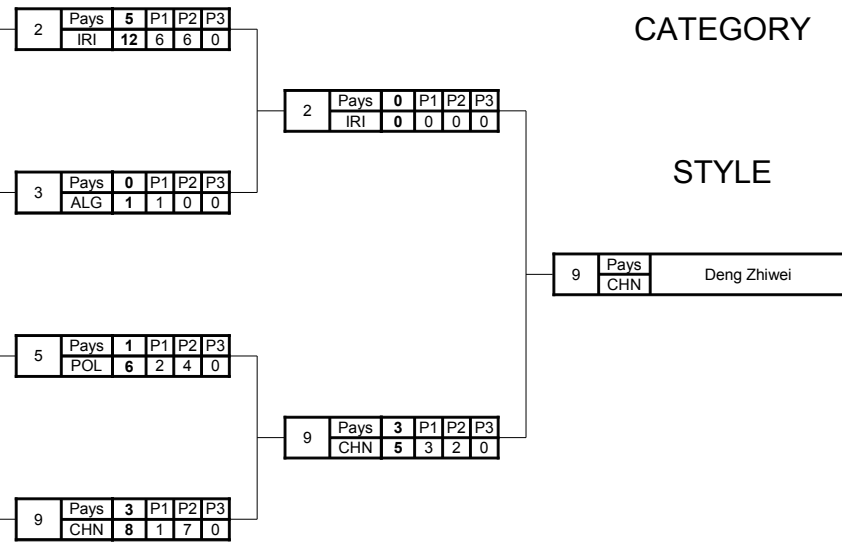

**REPECHAGE**

**Qualification round**

5	Pays	Baran Robert	3	P1	P2	P3
	POL		7	2	5	0
6	Pays	Han Hao	0	P1	P2	P3
	CHN		0	0	0	0
7	Pays	Umarov Anushervon	0	P1	P2	P3
	TJK		0	0	0	0
8	Pays	Shang Hai	5	P1	P2	P3
	CHN		0	0	0	0
9	Pays	Deng Zhiwei	0	P1	P2	P3
	CHN		10	10	0	0
10	Pays	Boban Danov	0	P1	P2	P3
	MKD		0	0	0	0
11	Pays	Korey Jarvis	5	P1	P2	P3
	CAN		0	0	0	0
12	Pays	Jalilau Yusup	0	P1	P2	P3
	BLR		0	0	0	0
	Pays			P1	P2	P3
	Pays			P1	P2	P3
	Pays			P1	P2	P3
	Pays			P1	P2	P3

**LOWER BRANCH**

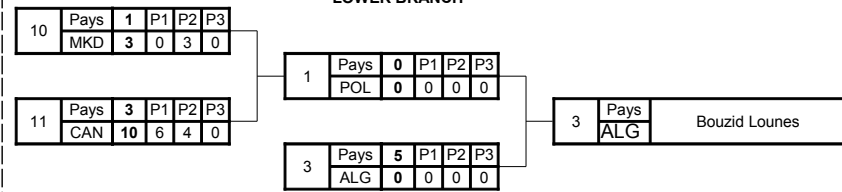

**UPPER BRANCH**

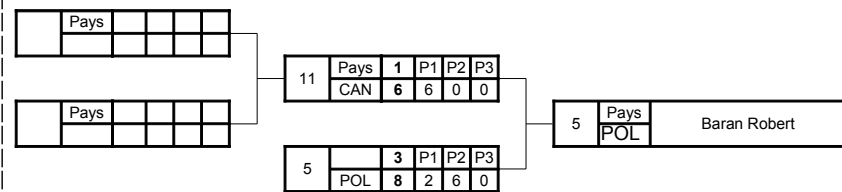

Rank	No	Name	Country	C.P	Falls	E.M.	E.R	Win Points	Lost Points
1	9	Deng Zhiwei	CHN	9	0	0	2	30	6
2	2	Amirreza Amiri	IRI	10	1	0	1	12	6
3	5	Baran Robert	POL	12	1	0	2	31	20
3	3	Bouزيد Lounes	ALG	10	1	0	0	9	13
5	11	Korey Jarvis	CAN	9	0	0	1	16	18
5	1	Skaskewicz K.	POL	0	0	0	0	0	0
7	8	Shang Hai	CHN	5	0	0	0	6	10
8	10	Boban Danov	MKD	1	0	0	0	3	20
9	4	Uharek Tomas	SVK	0	0	0	0	1	8
10	12	Jalilau Yusup	BLR	0	0	0	0	0	0
11	7	Umarov Anushervon	TJK	0	0	0	0	0	0
12	6	Han Hao	CHN	0	0	0	0	0	7



# INTERNATIONAL WRESTLING TOURNAMENT - SENIORS - FS

“DAN KOLOV - NIKOLA PETROV”, 29-31.1.2016, SOFIA

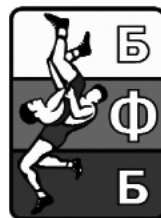

1	Pays	Franklin Gomez	3	P1	P2	P3
	PUR		7	2	5	0

2	Pays	Filip Novachkov	1	P1	P2	P3
	BUL		1	1	0	0

3	Pays	Mishel Mihaylov	1	P1	P2	P3
	BUL		6	6	0	0

4	Pays	Mehdi Niaziyengheshlaghi	3	P1	P2	P3
	IRI		14	4	10	0

6	Pays	Dejan Mitrov	4	P1	P2	P3
	MKD		11	5	6	0

8	Pays	Jasin Redjalari	0	P1	P2	P3
	MKD		0	0	0	0

9	Pays	Borislav Novachkov	3	P1	P2	P3
	BUL		5	2	3	0

11	Pays	Batbold Nomin	0	P1	P2	P3
	MGL		0	0	0	0

1	Pays	4	P1	P2	P3
	PUR	10	8	2	0

4	Pays	0	P1	P2	P3
	IRI	0	0	0	0

6	Pays	0	P1	P2	P3
	MKD	0	0	0	0

9	Pays	4	P1	P2	P3
	BUL	10	4	6	0

CATEGORY **65**

STYLE **FS**

1	Pays	Franklin Gomez
	PUR	

## REPECHAGE

## Qualification round

5	Pays	Perpelita Andrei	1	P1	P2	P3
	MDA		2	2	0	0

6	Pays	Dejan Mitrov	3	P1	P2	P3
	MKD		4	2	2	0

7	Pays	Talamo Gianluca	1	P1	P2	P3
	ITA		8	2	6	0

8	Pays	Jasin Redjalari	3	P1	P2	P3
	MKD		10	4	6	0

9	Pays	Borislav Novachkov	4	P1	P2	P3
	BUL		10	10	0	0

10	Pays	Ait Amrane Mehdi	0	P1	P2	P3
	ALG		0	0	0	0

11	Pays	Batbold Nomin	3	P1	P2	P3
	MGL		7	1	6	0

12	Pays	Mykola Bolotnjuk	0	P1	P2	P3
	SVK		0	0	0	0

	Pays			P1	P2	P3

	Pays			P1	P2	P3

	Pays			P1	P2	P3

	Pays			P1	P2	P3

	Pays			P1	P2	P3

	Pays			P1	P2	P3

10	Pays	0	P1	P2	P3
	ALG	0	0	0	0

11	Pays	10	P1	P2	P3
	MGL	10	10	0	0

## LOWER BRANCH

11	Pays	5	P1	P2	P3
	MGL	4	4	0	0

6	Pays	0	P1	P2	P3
	MKD	1	1	0	0

11	Pays	Batbold Nomin
	MGL	

## UPPER BRANCH

2	Pays	5	P1	P2	P3
	BUL	9	3	6	0

4		0	P1	P2	P3
	IRI	3	0	3	0

2	Pays	Filip Novachkov
	BUL	

Rank	No	Name	Country	C.P	Falls	E.M.	E.R	Win Points	Lost Points
1	1	Franklin Gomez	PUR	10	0	0	1	21	1
2	9	Borislav Novachkov	BUL	11	0	0	2	25	4
3	11	Batbold Nomin	MGL	18	1	0	2	21	6
3	2	Filip Novachkov	BUL	6	1	0	0	10	10
5	6	Dejan Mitrov	MKD	7	0	0	1	16	16
5	4	Mehdi Niaziyengheshlaghi	IRI	3	0	0	1	17	25
7	8	Jasin Redjalari	MKD	3	0	0	0	10	19
8	7	Talamo Gianluca	ITA	1	0	0	0	8	10
9	3	Mishel Mihaylov	BUL	1	0	0	0	6	14
10	5	Perpelita Andrei	MDA	1	0	0	0	2	4
11	12	Mykola Bolotnjuk	SVK	0	0	0	0	0	7
12	10	Ait Amrane Mehdi	ALG	0	0	0	0	0	20



# INTERNATIONAL WRESTLING TOURNAMENT - SENIORS - FS

“DAN KOLOV - NIKOLA PETROV”, 29-31.1.2016, SOFIA

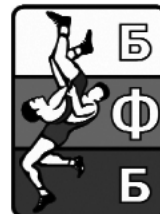

CATEGORY **70**

STYLE **FS**

2	Pays	Nikolay Kurtev	3	P1	P2	P3
	BUL		6	2	4	0
4	Pays	Sava Mihail	1	P1	P2	P3
	MDA		3	1	2	0
6	Pays	Miroslav Hristov	0	P1	P2	P3
	BUL		0	0	0	0
8	Pays	Gadzhiev Magomedmurad	4	P1	P2	P3
	POL		11	3	8	0

2	Pays		0	P1	P2	P3
	BUL		0	0	0	0
8	Pays	Gadzhiev Magomedmurad	3	P1	P2	P3
	POL		1	1	1	0

REPECHAGE						
LOWER BRANCH						
1	Pays	Georgi Zlatov	3	P1	P2	P3
	BUL		11	1	10	0
4	Pays	Sava Mihail	1	P1	P2	P3
	MDA		4	2	2	0
UPPER BRANCH						
7	Pays	Oktay Salim	5	P1	P2	P3
	BUL		6	6	0	0
6	Pays	Gadzhiev Magomedmurad	0	P1	P2	P3
	BUL		3	3	0	0

**Qualification round**

1	Pays	Georgi Zlatov	0	P1	P2	P3
	BUL		0	0	0	0
2	Pays	Nikolay Kurtev	3	P1	P2	P3
	BUL		7	5	2	0
3	Pays	Lallouch Nasr Allah	0	P1	P2	P3
	ALG		0	0	0	0
4	Pays	Sava Mihail	4	P1	P2	P3
	MDA		10	6	4	0
5	Pays	Juan Pablo	0	P1	P2	P3
	CHI		0	0	0	0
6	Pays	Miroslav Hristov	5	P1	P2	P3
	BUL		4	4	0	0
7	Pays	Oktay Salim	0	P1	P2	P3
	BUL		0	0	0	0
8	Pays	Gadzhiev Magomedmurad	4	P1	P2	P3
	POL		10	6	4	0

Rank	No	Name	Country	C.P	Falls	E.M.	E.R	Win Points	Lost Points
1	8	Gadzhiev Magomedmurad	POL	11	0	0	2	22	0
2	2	Nikolay Kurtev	BUL	6	0	0	0	13	4
3	1	Georgi Zlatov	BUL	3	0	0	1	11	11
3	7	Oktay Salim	BUL	5	1	0	0	6	13
5	4	Sava Mihail	MDA	6	0	0	1	17	17
5	6	Miroslav Hristov	BUL	5	1	0	0	7	17
7	5	Juan Pablo	CHI	0	0	0	0	0	4
8	3	Lallouch Nasr Allah	ALG	0	0	0	0	0	10



# INTERNATIONAL WRESTLING TOURNAMENT - SENIORS - FS

“DAN KOLOV - NIKOLA PETROV”, 29-31.1.2016, SOFIA

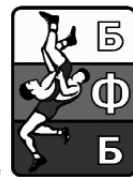

1	Pays	Aylin Ashim	5	P1	P2	P3
	BUL		0	0	0	0
2	Pays	Marcinkiewicz Radoslaw	0	P1	P2	P3
	POL		0	0	0	0
4	Pays	Jozef Jaloviar	1	P1	P2	P3
	SVK		1	0	1	0
6	Pays	Balawender Maciej	3	P1	P2	P3
	POL		7	5	2	0
7	Pays	Baran Radoslaw	3	P1	P2	P3
	POL		9	4	5	0
10	Pays	Dragomir Stoychev	0	P1	P2	P3
	BUL		0	0	0	0
11	Pays	Edon Shala	1	P1	P2	P3
	KOS		2	2	0	0
14	Pays	Egzon Shala	4	P1	P2	P3
	ALB		12	12	0	0

1	Pays	0	P1	P2	P3
	BUL	4	4	0	0
6	Pays	5	P1	P2	P3
	POL	14	6	8	0
7	Pays	4	P1	P2	P3
	POL	20	5	15	0
14	Pays	0	P1	P2	P3
	ALB	10	4	6	0

6	Pays	0	P1	P2	P3
	POL	2	2	0	0
7	Pays	5	P1	P2	P3
	POL	4	4	0	0

7	Pays	Baran Radoslaw
	POL	

CATEGORY

**97**

STYLE

**FS**

**REPECHAGE**

**Qualification round**

3	Pays	Masoud Khajehsalehani	1	P1	P2	P3
	IRI		2	0	2	0
4	Pays	Jozef Jaloviar	3	P1	P2	P3
	SVK		4	1	3	0
5	Pays	Gabriel Tysz	0	P1	P2	P3
	SVK		0	0	0	0
6	Pays	Balawender Maciej	5	P1	P2	P3
	POL		8	8	0	0
7	Pays	Baran Radoslaw	4	P1	P2	P3
	POL		11	11	0	0
8	Pays	Iren Yurukov	0	P1	P2	P3
	BUL		0	0	0	0
9	Pays	Rene Matejov	1	P1	P2	P3
	SVK		2	0	2	0
10	Pays	Dragomir Stoychev	3	P1	P2	P3
	BUL		2	2	0	0
11	Pays	Edon Shala	4	P1	P2	P3
	KOS		10	4	6	0
12	Pays	Angel Gochev	0	P1	P2	P3
	BUL		0	0	0	0
13	Pays	Zhang Xueyi	0	P1	P2	P3
	CHN		4	4	0	0
14	Pays	Egzon Shala	5	P1	P2	P3
	ALB		2	2	0	0
	Pays			P1	P2	P3
	Pays			P1	P2	P3

8	Pays	1	P1	P2	P3
	BUL	1	1	0	0
10	Pays	3	P1	P2	P3
	BUL	5	1	4	0
5	Pays	0	P1	P2	P3
	SVK	0	0	0	0
4	Pays	5	P1	P2	P3
	SVK	5	5	0	0

**LOWER BRANCH**

4	Pays	5	P1	P2	P3
	SVK	4	0	4	0
1	Pays	0	P1	P2	P3
	BUL	0	0	0	0

4	Pays	Jozef Jaloviar
	SVK	

**UPPER BRANCH**

10	Pays	1	P1	P2	P3
	BUL	7	2	5	0
4	Pays	5	P1	P2	P3
	ALB	9	2	7	0

14	Pays	Egzon Shala
	ALB	

Rank	No	Name	Country	C.P	Falls	E.M.	E.R	Win Points	Lost Points
1	7	Baran Radoslaw	POL	16	0	0	2	44	12
2	6	Balawender Maciej	POL	13	2	0	2	31	9
3	14	Egzon Shala	ALB	12	1	0	1	33	33
3	4	Jozef Jaloviar	SVK	14	1	0	0	14	9
5	10	Dragomir Stoychev	BUL	7	0	0	0	14	21
5	1	Aylin Ashim	BUL	5	0	0	0	4	18
7	11	Edon Shala	KOS	5	0	0	1	12	12
8	9	Rene Matejov	SVK	1	0	0	0	2	2
9	3	Masoud Khajehsalehani	IRI	1	0	0	0	2	4
10	8	Iren Yurukov	BUL	1	0	0	0	1	16
11	13	Zhang Xueyi	CHN	0	0	0	0	4	2
12	2	Marcinkiewicz Radoslaw	POL	0	0	0	0	0	0
13	12	Angel Gochev	BUL	0	0	0	0	0	10
14	5	Gabriel Tysz	SVK	0	0	0	0	0	13

# INTERNATIONAL WRESTLING TOURNAMENT - SENIORS

## "DAN KOLOV - NIKOLA PETROV", 28-31.01.2016, SOFIA

### CATEGORY 55 STYLE FW

No	Country	Name	I Round				II Round				III Round				Total	Pl.				
1	Pays	Biliana Dudova	2	3	P1	P2	P3	3	4	P1	P2	P3	4	5	P1	P2	P3	pp	12	1
	BUL			8	2	6	0		10	10	0	0		5	3	2	0	pt	23	
2	Pays	Elif Yanik	1	1	P1	P2	P3	4	1	P1	P2	P3	3	5	P1	P2	P3	pp	7	2
	TUR			2	2	0	0		3	1	2	0		12	12	0	0	pt	17	
3	Pays	Menka Stoyanovska	4	0	P1	P2	P3	1	0	P1	P2	P3	2	0	P1	P2	P3	pp	0	4
	MKD			0	0	0	0		0	0	0	0		1	1	0	0	pt	1	
4	Pays	Liuzzi Patrizia	3	4	P1	P2	P3	2	3	P1	P2	P3	1	0	P1	P2	P3	pp	7	3
	ITA			13	13	0	0		10	6	4	0		0	2	0	0	pt	23	

### CATEGORY 60 STYLE FW

No	Country	Name	I Round				II Round				III Round				Total	Pl.				
1	Pays	Lamalsa Rabia	2	0	P1	P2	P3	3	0	P1	P2	P3	4	5	P1	P2	P3	pp	5	3
	ALG			0	0	0	0		0	0	0	0		2	2	0	0	pt	2	
2	Pays	Dzhanan Manolova	1	0	P1	P2	P3	4	5	P1	P2	P3	3	3	P1	P2	P3	pp	8	1
	BUL			0	4	0	0		10	10	0	0		3	1	2	0	pt	13	
3	Pays	Sofia Georgieva	4	4	P1	P2	P3	1	4	P1	P2	P3	2	0	P1	P2	P3	pp	8	2
	BUL			10	10	0	0		10	6	4	0		0	0	0	pt	20		
4	Pays	Ozlem Goldag	3	0	P1	P2	P3	2	0	P1	P2	P3	1	0	P1	P2	P3	pp	0	4
	TUR			0	0	0	0		0	0	0	0		2	2	0	0	pt	2	

### CATEGORY 69 STYLE FW

No	Country	Name	I Round				II Round				III Round				IV Round				V Round				Total	Pl.		
1	Pays	Burcu Ugduler	2	1	P1	P2	P3	5	1	P1	P2	P3	4	0	P1	P2	P3	3	0	P1	P2	P3		pp	2	5
	TUR			1	1	0	0		3	3	0	0		0	0	0	0		0	0	0	0			0	
2	Pays	Viktoria Bobeva	1	3	P1	P2	P3	3	0	P1	P2	P3	5	5	P1	P2	P3		4	0	P1	P2	P3	pp	8	3
	BUL			2	2	0	0		0	0	0	2		2	0	0	0			0	0	0	0		0	
3	Pays	Stadnik Alina	4	3	P1	P2	P3	2	4	P1	P2	P3		1	3	P1	P2	P3	5	5	P1	P2	P3	pp	15	1
	UKR			4	4	0	0		10	6	4	0			8	5	3	0		6	2	4	0		pt	
4	Pays	Cherkasova Alla	3	1	P1	P2	P3		1	5	P1	P2	P3	5	4	P1	P2	P3	2	4	P1	P2	P3	pp	14	2
	UKR			1	1	0	0			8	8	0	0		10	10	0	0		10	10	0	0		pt	
5	Pays	Gabriela Peycheva		1	3	P1	P2	P3	2	0	P1	P2	P3	4	0	P1	P2	P3	3	0	P1	P2	P3	pp	3	4
	BUL				4	0	4	0		0	0	0	0		0	0	0	0		0	0	0	0		0	

### CATEGORY 63 STYLE FW

No	Country	Name	I Round				II Round				III Round				Total	Pl.				
1	Pays	Taybe Yusein	2	4	P1	P2	P3	3	4	P1	P2	P3	4	0	P1	P2	P3	pp	8	2
	BUL			10	10	0	0		8	4	4	0		6	2	4	0	pt	24	
2	Pays	Ezgi Kuscu	1	0	P1	P2	P3	4	0	P1	P2	P3	3	0	P1	P2	P3	pp	0	4
	TUR			0	0	0	0		0	0	0	0		0	0	0	0	0	0	
3	Pays	Elina Vaseva	4	1	P1	P2	P3	1	0	P1	P2	P3	2	4	P1	P2	P3	pp	5	3
	BUL			2	2	0	0		0	0	0	8		8	0	0	pt	10		
4	Pays	Tkach Yulia	3	4	P1	P2	P3	2	4	P1	P2	P3	1	4	P1	P2	P3	pp	12	1
	UKR			12	8	4	0		2	2	0	0		6	4	2	0	pt	20	

### CATEGORY 75 STYLE FW

No	Country	Name	I Round				II Round				III Round				Total	Pl.
1	Pays	Svetlana Saenko	2	5	P1	P2	P3	3	4	P1	P2	P3		pp	9	1
	MDA			6	6	0	0		10	4	6	0			pt	
2	Pays	Aysegul Ozbege	1	0	P1	P2	P3		3	0	P1	P2	P3	pp	0	3
	TUR			0	0	0	0			2	2	0	0		pt	
3	Pays	Boriana Borisova		1	0	P1	P2	P3	2	5	P1	P2	P3	pp	5	2
	BUL				0	0	0	0		4	4	0	0		pt	



# INTERNATIONAL WRESTLING TOURNAMENT - SENIORS- FW

## “DAN KOLOV - NIKOLA PETROV”, 29-31.1.2016, SOFIA



CATEGORY **48**

STYLE **FW**

1	Pays	ARG	Patricia Bermudez	3	P1	P2	P3		
				10	7	3	0		
3	Pays	TUR	Sumeyye Sezer	1	P1	P2	P3		
				8	6	2	0		
5	Pays	BUL	Pepa Dimitrova	1	P1	P2	P3		
				2	2	0	0		
6	Pays	UKR	Pulkovska Nataliya	3	P1	P2	P3		
				9	0	9	0		

1	Pays	ARG	Patricia Bermudez	3	P1	P2	P3		
				10	4	6	0		
6	Pays	UKR		1	P1	P2	P3		
				4	0	4	0		

**Qualification round**

2	Pays	ALG	Salaouandji Hanene	0	P1	P2	P3		
				0	0	0	0		
3	Pays	TUR	Sumeyye Sezer	5	P1	P2	P3		
				9	9	0	0		
4	Pays	ALG	Yahiaoui Kheira Chaimaa	0	P1	P2	P3		
				0	0	0	0		
5	Pays	BUL	Pepa Dimitrova	4	P1	P2	P3		
				10	6	4	0		
6	Pays	UKR	Pulkovska Nataliya	5	P1	P2	P3		
				10	6	4	0		
7	Pays	BUL	Miglena Selishka	0	P1	P2	P3		
				0	0	0	0		

3	Pays	TUR	Sumeyye Sezer	0	P1	P2	P3		
				0	0	0	0		
7	Pays	BUL	Miglena Selishka	3	P1	P2	P3		
				9	1	8	0		
5	Pays	BUL		0	P1	P2	P3		
				0	0	0	0		

REPECHAGE

LOWER BRANCH

UPPER BRANCH

Rank	No	Name	Country	C.P	Falls	E.M.	E.R	Win Points	Lost Points
1	1	Patricia Bermudez	ARG	6	0	0	0	20	12
2	6	Pulkovska Nataliya	UKR	9	1	0	2	23	12
3	7	Miglena Selishka	BUL	3	0	0	1	9	10
5	5	Pepa Dimitrova	BUL	5	0	0	1	12	18
7	3	Sumeyye Sezer	TUR	6	1	0	1	17	10
8	2	Salaouandji Hanene	ALG	0	0	0	0	0	9
9	4	Yahiaoui Kheira Chaimaa	ALG	0	0	0	0	0	10



# INTERNATIONAL WRESTLING TOURNAMENT - SENIORS- FW

"DAN KOLOV - NIKOLA PETROV", 29-31.1.2016, SOFIA



1	Pays	Cherdivare Mariana	5	P1	P2	P3
	MDA		7	1	6	0

2	Pays	Vasylenko Ganna	0	P1	P2	P3
	UKR		0	0	0	0

3	Pays	Mimi Hristova	4	P1	P2	P3
	BUL		10	4	6	0

6	Pays	Husyak Iryna	0	P1	P2	P3
	UKR		0	0	0	0

CATEGORY **58**

STYLE **FW**

1	Pays	1	P1	P2	P3
	MDA	6	6	0	0

3	Pays	Mimi Hristova
	BUL	

3	Pays	3	P1	P2	P3
	BUL	7	1	6	0

**Qualification round**

3	Pays	Mimi Hristova	5	P1	P2	P3
	BUL		10	10	0	0

4	Pays	Benabdarrahmane Amina	0	P1	P2	P3
	ALG		0	0	0	0

5	Pays	Carieri Arianna	0	P1	P2	P3
	ITA		0	0	0	0

6	Pays	Husyak Iryna	5	P1	P2	P3
	UKR		4	4	0	0

	Pays			P1	P2	P3

	Pays			P1	P2	P3

	Pays			P1	P2	P3

	Pays			P1	P2	P3

4	Pays	0	P1	P2	P3
	ALG	2	2	0	0

6	Pays	Husyak Iryna
	UKR	

6	Pays	5	P1	P2	P3
	UKR	6	6	0	0

	Pays		P1	P2	P3

2	Pays	Vasylenko Ganna
	UKR	

	Pays		P1	P2	P3

REPECHAGE

LOWER BRANCH

UPPER BRANCH

Category 58

Rank	No	Name	Country	C.P	Falls	E.M.	E.R	Win Points	Lost Points
1	3	Mimi Hristova	BUL	12	0	0	3	27	6
2	1	Cherdivare Mariana	MDA	6	1	0	1	13	7
3	6	Husyak Iryna	UKR	10	2	0	0	10	12
5	4	Benabdarrahmane Amina	ALG	0	0	0	0	2	16
7	5	Carieri Arianna	ITA	0	0	0	0	0	4
8	2	Vasylenko Ganna	UKR	0	0	0	0	0	7



# INTERNATIONAL WRESTLING TOURNAMENT - SENIORS- FW

“DAN KOLOV - NIKOLA PETROV”, 29-31.1.2016, SOFIA



CATEGORY **53**

STYLE **FW**

1	Pays BUL	Aleksandrina Kashinova	0	P1	P2	P3
			0	0	0	0
2	Pays GRE	Prevolarakhi Maria	3	P1	P2	P3
			8	2	6	0
5	Pays MDA	Budu Natalia	3	P1	P2	P3
			3	0	3	0
7	Pays MDA	Leorda Iulia	1	P1	P2	P3
			1	1	0	0

<b>Qualification round</b>						
2	Pays GRE	Prevolarakhi Maria	5	P1	P2	P3
			8	2	6	0
3	Pays ITA	Tronccone Anna Maria	0	P1	P2	P3
			0	0	0	0
4	Pays TUR	Firkiye Gok	0	P1	P2	P3
			0	0	0	0
5	Pays MDA	Budu Natalia	5	P1	P2	P3
			4	4	0	0
6	Pays UKR	Shnaider Olga	0	P1	P2	P3
			0	0	0	0
7	Pays MDA	Leorda Iulia	4	P1	P2	P3
			10	6	4	0
	Pays			P1	P2	P3
	Pays			P1	P2	P3

REPECHAGE

LOWER BRANCH

UPPER BRANCH

Rank	No	Name	Country	C.P	Falls	E.M.	E.R	Win Points	Lost Points
1	2	Prevolarakhi Maria	GRE	11	1	0	2	19	2
2	5	Budu Natalia	MDA	9	1	0	0	9	4
3	7	Leorda Iulia	MDA	9	0	0	2	23	5
3	1	Aleksandrina Kashinova	BUL	5	1	0	0	3	8
5	4	Firkiye Gok	TUR	1	0	0	0	2	16
5	3	Tronccone Anna Maria	ITA	0	0	0	0	0	11
7	6	Shnaider Olga	UKR	0	0	0	0	0	10





# INTERNATIONAL WRESTLING TOURNAMENT - SENIORS - GR

\*DAN KOLOV - NIKOLA PETROV\*, 29-31.1.2016, SOFIA

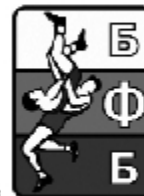

1	Pays BUL	Aleksandar Kostadinov	4	P1	P2	P3
			8	8	0	0
2	Pays BUL	Stefan Grigorov	0	P1	P2	P3
			0	0	0	0
3	Pays EGY	Rabie Taha Ahmed	3	P1	P2	P3
			6	5	1	0
4	Pays VEN	Raibez Rodriguez	1	P1	P2	P3
			6	0	6	0
7	Pays BUL	Radoslav Vasilev	3	P1	P2	P3
			6	2	4	0
8	Pays BUL	Nikolay Vichev	1	P1	P2	P3
			6	4	2	0
11	Pays ARM	Gevorg Gharibyan	4	P1	P2	P3
			8	8	0	0
13	Pays IRI	Mohammadreza Gerai	0	P1	P2	P3
			0	0	0	0

1	Pays BUL	4	P1	P2	P3
		10	10	0	0

1	Pays BUL	3	P1	P2	P3
		6	6	0	0

3	Pays EGY	0	P1	P2	P3
		0	0	0	0

7	Pays BUL	1	P1	P2	P3
		1	1	0	0

11	Pays ARM	0	P1	P2	P3
		0	0	0	0

11	Pays ARM	4	P1	P2	P3
		10	4	6	0

CATEGORY **59**

STYLE **GR**

1	Pays BUL	Aleksandar Kostadinov
---	-------------	-----------------------

### REPECHAGE

### Qualification round

4	Pays VEN	Raibez Rodriguez	4	P1	P2	P3
			8	8	0	0
5	Pays ARM	Narek Khachatryan	0	P1	P2	P3
			0	0	0	0
6	Pays ITA	Marvice Ruben	1	P1	P2	P3
			4	1	3	0
7	Pays BUL	Radoslav Vasilev	3	P1	P2	P3
			6	4	2	0
8	Pays BUL	Nikolay Vichev	4	P1	P2	P3
			9	6	3	0
9	Pays BUL	Avgustin Spasov	0	P1	P2	P3
			0	0	0	0
10	Pays ALG	Djedaiet Mouatez	0	P1	P2	P3
			0	0	0	0
11	Pays ARM	Gevorg Gharibyan	4	P1	P2	P3
			9	9	0	0
12	Pays BUL	Yoto Hristov	1	P1	P2	P3
			2	2	0	0
13	Pays IRI	Mohammadreza Gerai	4	P1	P2	P3
			10	9	1	0
	Pays			P1	P2	P3
	Pays			P1	P2	P3
	Pays			P1	P2	P3

10	Pays ALG	0	P1	P2	P3
		0	1	0	0

13	Pays IRI	5	P1	P2	P3
		10	6	4	0

### LOWER BRANCH

2	Pays BUL	0	P1	P2	P3
		0	0	0	0

3	Pays EGY	4	P1	P2	P3
		9	9	0	0

3	Pays EGY	Rabie Taha Ahmed
---	-------------	------------------

### UPPER BRANCH

	Pays				
--	------	--	--	--	--

	Pays				
--	------	--	--	--	--

13	Pays IRI	3	P1	P2	P3
		8	6	2	0

7		1	P1	P2	P3
	BUL	8	4	2	0

13	Pays IRI	Mohammadreza Gerai
----	-------------	--------------------

Rank	No	Name	Country	C.P	Falls	E.M.	E.R	Win Points	Lost Points
1	1	Aleksandar Kostadinov	BUL	11	0	0	3	24	0
2	11	Gevorg Gharibyan	ARM	12	0	0	3	27	7
3	13	Mohammadreza Gerai	IRI	12	1	0	1	28	18
3	3	Rabie Taha Ahmed	EGY	7	0	0	1	15	16
5	7	Radoslav Vasilev	BUL	8	0	0	0	21	28
5	2	Stefan Grigorov	BUL	0	0	0	0	0	17
7	8	Nikolay Vichev	BUL	5	0	0	1	15	6
8	4	Raibez Rodriguez	VEN	5	0	0	1	14	6
9	6	Marvice Ruben	ITA	1	0	0	0	4	6
10	12	Yoto Hristov	BUL	1	0	0	0	2	10
11	5	Narek Khachatryan	ARM	0	0	0	0	0	8
12	9	Avgustin Spasov	BUL	0	0	0	0	0	9
13	10	Djedaiet Mouatez	ALG	0	0	0	0	0	19



# INTERNATIONAL WRESTLING TOURNAMENT - SENIORS - GR

\*DAN KOLOV - NIKOLA PETROV\*, 29-31.1.2016, SOFIA



1	Pays	Kristiyan Toshkov	0	P1	P2	P3
	BUL		0	0	0	0
2	Pays	Luis Avendano	4	P1	P2	P3
	VEN		8	8	0	0
3	Pays	Karapet Chalyan	3	P1	P2	P3
	ARM		4	2	2	0
4	Pays	Stilian Naydenov	0	P1	P2	P3
	BUL		0	0	0	0
5	Pays	Iliyan Georgiev	4	P1	P2	P3
	BUL		9	4	5	0
7	Pays	Russo Ciro	0	P1	P2	P3
	ITA		0	0	0	0
9	Pays	Atanas Kolev	0	P1	P2	P3
	BUL		0	0	0	0
10	Pays	Daniel Aleksandrov	3	P1	P2	P3
	BUL		6	2	4	0

CATEGORY **75**

STYLE **GR**

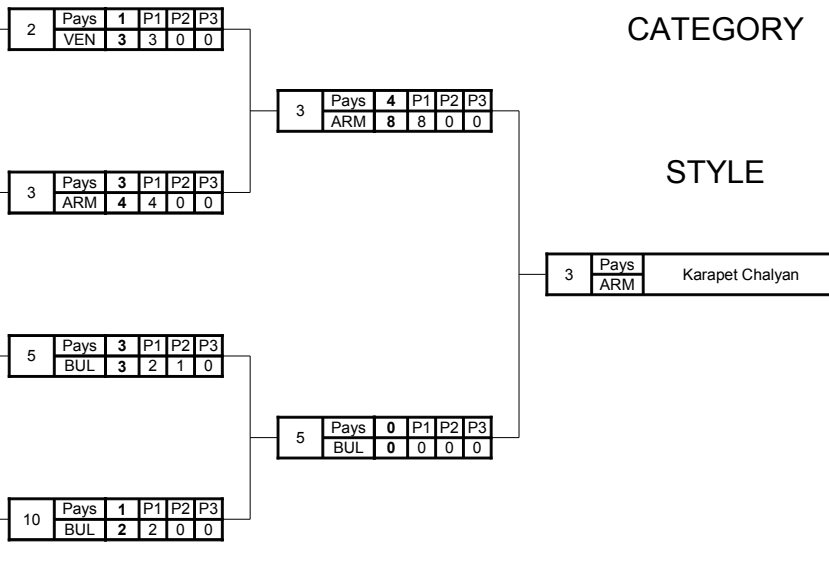

**Qualification round**

6	Pays	Ali Norouzi	1	P1	P2	P3
	IRI		1	1	0	0
7	Pays	Russo Ciro	3	P1	P2	P3
	ITA		4	4	0	0
8	Pays	Dariozzi Luca	1	P1	P2	P3
	ITA		1	1	0	0
9	Pays	Atanas Kolev	3	P1	P2	P3
	BUL		8	5	3	0
10	Pays	Daniel Aleksandrov	3	P1	P2	P3
	BUL		6	2	4	0
11	Pays	Rosian Dermanski	0	P1	P2	P3
	BUL		0	0	0	0
	Pays			P1	P2	P3
	Pays			P1	P2	P3
	Pays			P1	P2	P3
	Pays			P1	P2	P3
	Pays			P1	P2	P3

**REPECHAGE**

**LOWER BRANCH**

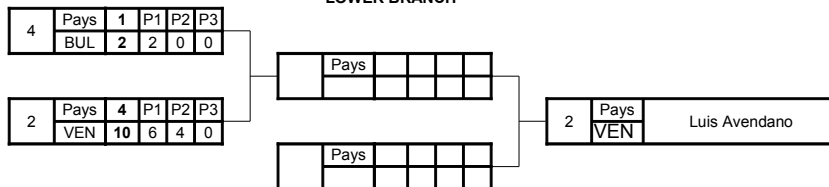

**UPPER BRANCH**

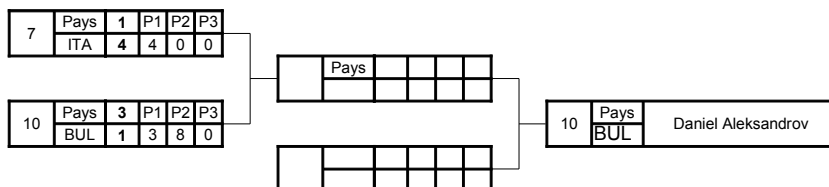

Rank	No	Name	Country	C.P	Falls	E.M.	E.R	Win Points	Lost Points
1	3	Karapet Chalyan	ARM	10	0	0	1	16	3
2	5	Iliyan Georgiev	BUL	7	0	0	0	12	10
3	10	Daniel Aleksandrov	BUL	10	0	0	1	15	7
3	2	Luis Avendano	VEN	9	0	0	1	21	6
5	7	Russo Ciro	ITA	4	0	0	0	8	11
5	4	Stilian Naydenov	BUL	1	0	0	0	2	14
7	9	Atanas Kolev	BUL	3	0	0	0	8	7
8	6	Ali Norouzi	IRI	1	0	0	0	1	4
9	8	Dariozzi Luca	ITA	1	0	0	0	1	8
10	11	Rosian Dermanski	BUL	0	0	0	0	0	6
11	1	Kristiyan Toshkov	BUL	0	0	0	0	0	8



# INTERNATIONAL WRESTLING TOURNAMENT - SENIORS - GR

"DAN KOLOV - NIKOLA PETROV", 29-31.1.2016, SOFIA



CATEGORY **130**

STYLE **GR**

1	Pays ARM	Edgar Khachatryan	1 5	P1 5	P2 0	P3 0
2	Pays BUL	Lyubomir Dimitrov	4 14	P1 10	P2 4	P3 0
4	Pays VEN	Erwin Caraballo	1 4	P1 4	P2 0	P3 0
6	Pays BUL	Miloslav Metodiev	3 5	P1 5	P2 0	P3 0
2	Pays BUL	Lyubomir Dimitrov	4 8	P1 4	P2 4	P3 0
6	Pays BUL	Miloslav Metodiev	0 0	P1 0	P2 0	P3 0

REPECHAGE						
LOWER BRANCH						
1	Pays ARM	Edgar Khachatryan	0 0	P1 0	P2 0	P3 0
1	Pays ARM	Edgar Khachatryan	0 0	P1 0	P2 0	P3 0
UPPER BRANCH						
5	Pays EGY	Abdellatif Mohamed	4 8	P1 3	P2 5	P3 0
5	Pays EGY	Abdellatif Mohamed	4 8	P1 3	P2 5	P3 0
4	Pays VEN	Erwin Caraballo	0 0	P1 0	P2 0	P3 0

**Qualification round**

3	Pays IRI	Amin Mirzazadeh	1 2	P1 1	P2 1	P3 0
4	Pays VEN	Erwin Caraballo	3 5	P1 5	P2 0	P3 0
5	Pays EGY	Abdellatif Mohamed	1 2	P1 1	P2 1	P3 0
6	Pays BUL	Miloslav Metodiev	4 10	P1 10	P2 0	P3 0
	Pays			P1	P2	P3
	Pays			P1	P2	P3
	Pays			P1	P2	P3
	Pays			P1	P2	P3

Rank	No	Name	Country	C.P	Falls	E.M.	E.R	Win Points	Lost Points
1	2	Lyubomir Dimitrov	BUL	8	0	0	0	22	5
2	6	Miloslav Metodiev	BUL	7	0	0	1	15	14
3	5	Abdellatif Mohamed	EGY	5	0	0	0	10	10
5	4	Erwin Caraballo	VEN	4	0	0	0	9	15
7	1	Edgar Khachatryan	ARM	1	0	0	0	5	14
8	3	Amin Mirzazadeh	IRI	1	0	0	0	2	5



# INTERNATIONAL WRESTLING TOURNAMENT - SENIORS - GR

\*DAN KOLOV - NIKOLA PETROV\*, 29-31.1.2016, SOFIA



**CATEGORY 71  
STYLE GR**

No	Country	Name	I Round	II Round	III Round	IV Round	V Round	Total	Pl.
1	Pays	Maykal Izmirliyski	2	0	0	0	0	pp 0 pt 0	5
	BUL		0	0	0	0			
2	Pays	Cascavilla Davide	1	4	4	0	4	pp 8 pt 17	3
	ITA		8	9	0	0			
3	Pays	Adham Ahmed Saleh	4	3	0	1	5	pp 7 pt 8	4
	EGY		8	0	0				
4	Pays	Boudjemline Akrem	3	1	5	5	2	pp 10 pt 15	2
	ALG		7	0	0				
5	Pays	Migran Arutyunyan	1	4	4	4	3	pp 15 pt 35	1
	ARM		9	10	0				

Rank	No	Name	Country	C.P	Falls	E.M.	E.R	Win Points	Lost Points
1	5	Migran Arutyunyan	ARM	15	1	0	3	35	0
2	4	Boudjemline Akrem	ALG	10	0	0	1	15	20
3	2	Cascavilla Davide	ITA	8	0	0	2	17	18
4	3	Adham Ahmed Saleh	EGY	7	0	0	1	8	20
5	1	Maykal Izmirliyski	BUL	0	0	0	0	0	17

**CATEGORY 80  
STYLE GR**

No	Country	Name	I Round	II Round	III Round	Total	Pl.
1	Pays	Mehdi Ebrahimi	2	3	3	9	2
	IRI		7	5			
2	Pays	Mahmoud Rashad	1	1	4	9	1
	EGY		3	10			
3	Pays	Keivan Rezaei Dalini	4	4	1	6	3
	IRI		8	2			
4	Pays	Mario Dotsin	3	0	1	1	4
	BUL		0	2			

Rank	No	Name	Country	C.P	Falls	E.M.	E.R	Win Points	Lost Points
1	2	Mahmoud Rashad	EGY	9	0	0	2	27	15
2	1	Mehdi Ebrahimi	IRI	9	0	0	0	18	5
3	3	Keivan Rezaei Dalini	IRI	6	0	0	1	16	19
4	4	Mario Dotsin	BUL	1	0	0	0	2	24



# INTERNATIONAL WRESTLING TOURNAMENT - SENIORS - GR

\*DAN KOLOV - NIKOLA PETROV\*, 29-31.1.2016, SOFIA

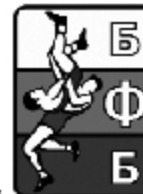

1	Pays	Elis Guri	3	P1	P2	P3
	BUL		8	2	6	0
2	Pays	Plamen Tashev	1	P1	P2	P3
	BUL		2	0	2	0
3	Pays	Mohammad Biranvand	1	P1	P2	P3
	IRI		2	2	0	0
4	Pays	Lully Perez	4	P1	P2	P3
	VEN		10	3	7	0
5	Pays	Artur Aleksanyan	4	P1	P2	P3
	ARM		8	8	0	0
6	Pays	Ahmed Osman	0	P1	P2	P3
	EGY		0	0	0	0
7	Pays	Haloui Hemza	0	P1	P2	P3
	ALG		0	0	0	0
10	Pays	Amirhossein Hosseini	3	P1	P2	P3
	IRI		5	1	4	0

CATEGORY

**98**

STYLE

**GR**

5	Pays	Artur Aleksanyan
	ARM	

1	Pays	4	P1	P2	P3
	BUL	8	4	4	0

1	Pays	4	P1	P2	P3
	BUL	8	4	4	0

4	Pays	0	P1	P2	P3
	VEN	0	0	0	0

5	Pays	4	P1	P2	P3
	ARM	8	6	2	0

5	Pays	3	P1	P2	P3
	ARM	4	2	2	0

10	Pays	0	P1	P2	P3
	IRI	0	0	0	0

**REPECHAGE**

**Qualification round**

7	Pays	Haloui Hemza	3	P1	P2	P3
	ALG		8	8	0	0
8	Pays	Simeon Stankovich	1	P1	P2	P3
	BUL		7	7	0	0
9	Pays	Vladislav Metodiev	1	P1	P2	P3
	BUL		9	9	0	0
10	Pays	Amirhossein Hosseini	3	P1	P2	P3
	IRI		12	4	8	0
	Pays			P1	P2	P3
	Pays			P1	P2	P3
	Pays			P1	P2	P3
	Pays			P1	P2	P3
	Pays			P1	P2	P3
	Pays			P1	P2	P3
	Pays			P1	P2	P3
	Pays			P1	P2	P3
	Pays			P1	P2	P3
	Pays			P1	P2	P3
	Pays			P1	P2	P3
	Pays			P1	P2	P3
	Pays			P1	P2	P3

**LOWER BRANCH**

6	Pays	1	P1	P2	P3
	EGY	6	4	2	0

Pays					
------	--	--	--	--	--

10	Pays	3	P1	P2	P3
	IRI	6	0	6	0

Pays					
------	--	--	--	--	--

10	Pays	Amirhossein Hosseini
	IRI	

**UPPER BRANCH**

2	Pays	1	P1	P2	P3
	BUL	4	4	0	0

Pays					
------	--	--	--	--	--

4	Pays	3	P1	P2	P3
	VEN	7	5	2	0

Pays					
------	--	--	--	--	--

4	Pays	Lully Perez
	VEN	

Category 98

Rank	No	Name	Country	C.P	Falls	E.M.	E.R	Win Points	Lost Points
1	5	Artur Aleksanyan	ARM	11	0	0	2	20	0
2	1	Elis Guri	BUL	7	0	0	0	16	6
3	10	Amirhossein Hosseini	IRI	9	0	0	1	23	23
3	4	Lully Perez	VEN	7	0	0	1	17	14
5	6	Ahmed Osman	EGY	1	0	0	0	6	14
5	2	Plamen Tashev	BUL	2	0	0	0	6	15
7	7	Haloui Hemza	ALG	3	0	0	0	8	12
8	9	Vladislav Metodiev	BUL	1	0	0	0	9	12
9	8	Simeon Stankovich	BUL	1	0	0	0	7	8
10	3	Mohammad Biranvand	IRI	1	0	0	0	2	10



# INTERNATIONAL WRESTLING TOURNAMENT - SENIORS - GR

## “DAN KOLOV - NIKOLA PETROV”, 29-31.1.2016, SOFIA



1	Pays	Mohammad Hasan Hossein	0	P1	P2	P3
	IRI		0	0	0	0
2	Pays	Svilen Kostadinov	3	P1	P2	P3
	BUL		4	2	2	0
3	Pays	Mahmoud Habibi	5	P1	P2	P3
	IRI		3	0	3	0
4	Pays	Hossein Assadi Kolmati	0	P1	P2	P3
	IRI		0	0	0	0
5	Pays	Konstantin Stas	5	P1	P2	P3
	BUL		11	11	0	0
6	Pays	Andrey Borisov	0	P1	P2	P3
	BUL		0	0	0	0
7	Pays	David Dimitrov	0	P1	P2	P3
	BUL		0	0	0	0
9	Pays	Wuilexis Rivas	4	P1	P2	P3
	VEN		8	8	0	0

CATEGORY

**66**

STYLE

**GR**

5	Pays	Konstantin Stas
	BUL	

2	Pays	0	P1	P2	P3
	BUL	0	0	0	0

3	Pays	0	P1	P2	P3
	IRI	0	0	0	0

5	Pays	4	P1	P2	P3
	BUL	10	6	4	0

9	Pays	1	P1	P2	P3
	VEN	3	2	1	0

**REPECHAGE**

**LOWER BRANCH**

	Pays				

1	Pays	Mohammad Hasan Hosseini
	IRI	

**UPPER BRANCH**

	Pays				

9	Pays	Wuilexis Rivas
	VEN	

**Qualification round**

8	Pays	Tarek Aziz	0	P1	P2	P3
	ALG		0	0	0	0
9	Pays	Wuilexis Rivas	3	P1	P2	P3
	VEN		4	0	4	0
	Pays			P1	P2	P3
	Pays			P1	P2	P3
	Pays			P1	P2	P3
	Pays			P1	P2	P3
	Pays			P1	P2	P3
	Pays			P1	P2	P3
	Pays			P1	P2	P3

1	Pays	3	P1	P2	P3
	IRI	6	4	2	0

3	Pays	0	P1	P2	P3
	IRI	0	0	0	0

6	Pays	0	P1	P2	P3
	BUL	0	0	0	0

9	Pays	4	P1	P2	P3
	VEN	8	8	0	0

Rank	No	Name	Country	C.P	Falls	E.M.	E.R	Win Points	Lost Points
1	5	Konstantin Stas	BUL	12	1	0	2	28	3
2	2	Svilen Kostadinov	BUL	8	1	0	1	10	10
3	1	Mohammad Hasan Hosseini	IRI	3	0	0	0	6	4
3	9	Wuilexis Rivas	VEN	12	0	0	2	23	7
5	6	Andrey Borisov	BUL	0	0	0	0	0	19
5	3	Mahmoud Habibi	IRI	5	1	0	0	3	12
7	4	Hossein Assadi Kolmati	IRI	0	0	0	0	0	3
8	8	Tarek Aziz	ALG	0	0	0	0	0	4
9	7	David Dimitrov	BUL	0	0	0	0	0	8



# INTERNATIONAL WRESTLING TOURNAMENT - SENIORS - GR

“DAN KOLOV - NIKOLA PETROV”, 29-31.1.2016, SOFIA

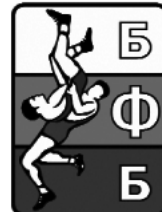

1	Pays	Keivan Rezaei	3	P1	P2	P3
	IRI		3	0	3	0
2	Pays	Boudjemline Adem	1	P1	P2	P3
	ALG		2	0	1	0
3	Pays	Ayran Ramadanovski	0	P1	P2	P3
	BUL		0	0	0	0
4	Pays	Nikolay Bayryakov	4	P1	P2	P3
	BUL		8	8	0	0
6	Pays	Mohamed Ahmed	0	P1	P2	P3
	EGY		3	3	0	0
7	Pays	Artur Shahinyan	5	P1	P2	P3
	ARM		5	5	0	0
10	Pays	Maksim Manukyan	4	P1	P2	P3
	ARM		8	8	0	0
12	Pays	Soheil Raeesi	0	P1	P2	P3
	IRI		0	0	0	0

1	Pays	0	P1	P2	P3
	IRI	0	0	0	0

4	Pays	3	P1	P2	P3
	BUL	2	0	2	0

4	Pays	3	P1	P2	P3
	BUL	6	5	1	0

10	Pays	0	P1	P2	P3
	ARM	0	0	0	0

10	Pays	3	P1	P2	P3
	ARM	3	3	0	0

CATEGORY

**85**

STYLE

**GR**

4	Pays	Nikolay Bayryakov
	BUL	

## REPECHAGE

### Qualification round

5	Pays	Yorgen Cova	1	P1	P2	P3
	VEN		1	1	0	0
6	Pays	Mohamed Ahmed	4	P1	P2	P3
	EGY		10	2	8	0
7	Pays	Artur Shahinyan	4	P1	P2	P3
	ARM		8	6	2	0
8	Pays	Sidazara Bachir	0	P1	P2	P3
	ALG		0	0	0	0
9	Pays	Hristo Marinov	0	P1	P2	P3
	BUL		0	0	0	0
10	Pays	Maksim Manukyan	3	P1	P2	P3
	ARM		4	4	0	0
11	Pays	Leonid Hristov	1	P1	P2	P3
	BUL		1	0	1	0
12	Pays	Soheil Raeesi	3	P1	P2	P3
	IRI		6	3	3	0
	Pays			P1	P2	P3
	Pays			P1	P2	P3
	Pays			P1	P2	P3
	Pays			P1	P2	P3
	Pays			P1	P2	P3
	Pays			P1	P2	P3
	Pays			P1	P2	P3

9	Pays	5	P1	P2	P3
	BUL	2	2	0	0

### LOWER BRANCH

3	Pays	1	P1	P2	P3
	BUL	8	2	6	0

12	Pays	0	P1	P2	P3
	IRI	0	0	0	0

1	Pays	3	P1	P2	P3
	IRI	10	4	6	0

1	Pays	Keivan Rezaei
	IRI	

### UPPER BRANCH

9	Pays	1	P1	P2	P3
	BUL	2	2	0	0

	Pays				
--	------	--	--	--	--

	Pays				
--	------	--	--	--	--

7		3	P1	P2	P3
	ARM	2	0	2	0

7	Pays	Artur Shahinyan
	ARM	

Rank	No	Name	Country	C.P	Falls	E.M.	E.R	Win Points	Lost Points
1	4	Nikolay Bayryakov	BUL	10	0	0	1	16	0
2	10	Maksim Manukyan	ARM	10	0	0	1	15	2
3	7	Artur Shahinyan	ARM	12	1	0	1	15	8
3	1	Keivan Rezaei	IRI	6	0	0	0	13	16
5	9	Hristo Marinov	BUL	6	1	0	0	4	6
5	3	Ayran Ramadanovski	BUL	1	0	0	0	8	18
7	6	Mohamed Ahmed	EGY	4	0	0	1	13	6
8	12	Soheil Raeesi	IRI	3	0	0	0	6	11
9	2	Boudjemline Adem	ALG	1	0	0	0	2	3
10	11	Leonid Hristov	BUL	1	0	0	0	1	6
11	5	Yorgen Cova	VEN	1	0	0	0	1	10
12	8	Sidazara Bachir	ALG	0	0	0	0	0	8

***The best international wrestler FW - Alina Stadnik, UKR, cat. 69 kg***  
***The best international wrestler GR - Migran Arutyunyan, ARM, cat. 71 kg***  
***The best international wrestler FS - Franklin Gomez, PUR, cat. 65 kg***  
***The best Bulgarian wrestler FW - Dzhanan Manolova, cat. 60 kg***  
***The Bearer of the Golden Belt GR - Lyubomir Dimitrov, cat. 130 kg***  
***The Bearer of the Golden Belt FS - Vladimir Dubov, cat. 57 kg***